

MDB777WP-DroneCAN General Specification.

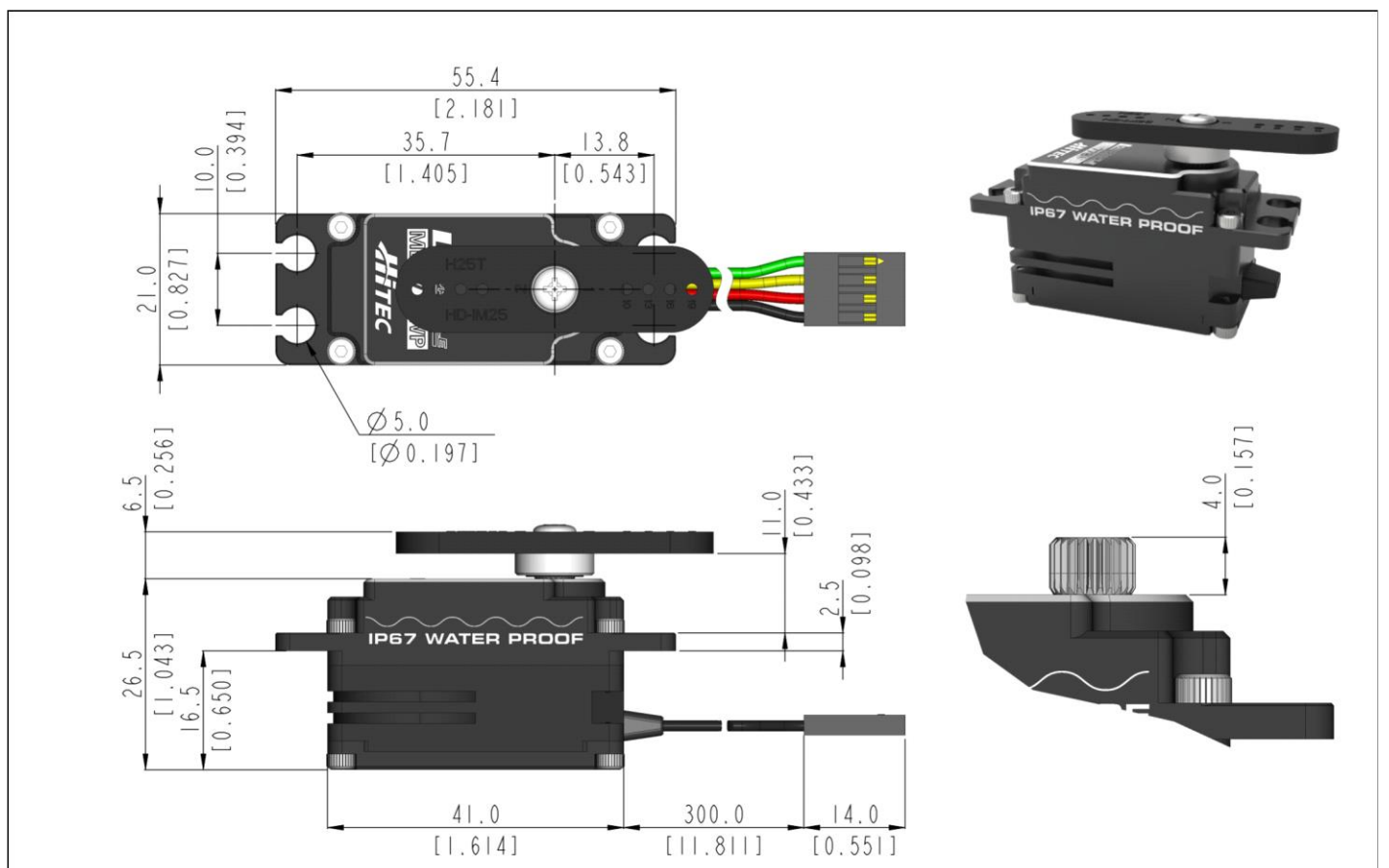

Control System	DroneCAN (UAVCAN v0)		-
Position Sensor Type	Contactless Magnetic Encoder		-
Motor Type	BLDC		At the Max voltage, it is recommended to be used only for a short time duration.
Operating Voltage Range	4.0 ~ 8.4V		
Voltage	-	6.0V	7.4V
No Load Speed	-	0.08sec/60°	0.06sec/60°
Stall Torque	-	8.0kgf-cm (111.1 oz-in)	11.0kgf-cm (152.76oz-in)
Peak Efficiency Torque	-	1.6kgf-cm (22.22oz-in)	2.2kgf-cm (30.55oz-in)
Standing Current	-	26mA	26mA
No Load Running Current	-	320mA	350mA
Stall Current	-	4,000mA	5,000mA
Deadband	-	n/a	n/a
Operating Travel	Servo Mode : ±60°(Default), ±150°(Programmable)		F/W v1.5 or Higher version
Continuous Rotation	n/a		-
Operating Temperature Range	-20°C ~ +60°C (-4°F ~ +140°F)		-
Storage Temperature Range	-30°C ~ +80°C (-22°F ~ +176°F)		-
Connector Wire Length	300mm (11.811inch)		
Connector Wire Gauge	20AWG		
Dimensions	41.0mm x 21.0mm x 26.5mm (1.614inch x 0.827inch x 1.043inch)		General Tolerance ±0.1mm
Weight	70.0g (2.469oz)		Excluding the weight of Horn
Bearing Type	2 Ball Bearing		-
Case Material	Aluminum Alloy		-
Gear Material	5 Hardened Steel Gears		-
Gear Train Backlash	Max 0.5°		-
Horn Gear Spline	25T(Ø6)		-
IP-Rating	IP67		-
Servo Amplifier Type	32bit programmable Digital		-



1:1 scale (Unit : mm[inch])

- This product should not be used directly on the human body for medical purposes.
- This product should not be used for war weapons.
- All specifications are subject to change without notice.
- Be careful as strong magnetic fields may cause malfunction of the product.

